

SECTION I

INTRODUCTION

The original Care and Feeding of Power Grid Tubes was published in 1967. Since then, Care and Feeding has been through four printings. This new, 5th edition includes most of the original material, but updates the book with some presently available technology, including added sections on Inductive Output Tubes and Multiphase Cooling.

This handbook analyzes the operation of EIMAC power grid tubes and provides design and application information to assist the user of these tubes to achieve long tube life, maximum operating efficiency and circuit stability consistent with the full tube capacity.

THE CARE AND FEEDING OF POWER GRID TUBES has been prepared in answer to thousands of questions asked of the EIMAC engineering and laboratory staff over a period of years. Data contained in this updated volume represents the combined efforts of these staff members to provide meaningful information on all phases of the design of equipment using power grid tubes, and the techniques recommended for the application of power grid tubes in modern circuits.

EIMAC transmitting and industrial power tubes are recommended for new equipment design and for replacement of older triode, tetrode and pentode tubes in the redesign of older equipment. Compact EIMAC tubes feature reduced internal coupling between input and output circuits, low internal inductance and capacitance, improved linearity and high operating efficiency. EIMAC tubes are built for long operating life and are rated for use well into the VHF or UHF regions. EIMAC tubes are designed to be rugged and can operate under extreme environmental conditions. The high power gain and excellent efficiency of EIMAC tubes permits design of equipment that operate with a minimum of drive power, allowing a minimum number of stages to achieve the desired power level.

Circuit design and application information in this book are applicable to all EIMAC power grid tubes. For specific ratings, operating parameters and information dealing with a particular tube type, refer to the Technical Data Sheet for the tube in question. Designers of new equipment are urged to contact EIMAC to get information on the range of the more important tube characteristics. Free copies of the data sheet may be obtained upon request to: Marketing Department, CPI, EIMAC Division, 301 Industrial Road, San Carlos, CA USA, 94070 or check EIMAC'S web site www.eimac.com.

For further technical information, contact EIMAC or your nearest CPI field sales office.

SECTION 2

WHAT IS A POWER GRID TUBE?

A power grid tube is a device utilizing the flow of free electrons in a vacuum. It has an emitting surface called the cathode, and one or more grids controlling the flow of electrons. An element called the anode collects the electrons. EIMAC manufactures gridded tubes which handle large amounts of power, as contrasted to receiving type tubes; hence, the term "Power Grid Tubes."

All gridded tubes must have a cathode and an anode. The general class of a tube, described by the terms "triode," "tetrode," and "pentode", is determined by the total number of elements within the tube envelope. Therefore, these terms also indicate the number of grids. A triode has one grid, a tetrode has two grids, and a pentode has three grids.

2.1 TRIODES

The total current flow from the cathode of a three-electrode tube is determined by the electrostatic field near the cathode. The electrostatic field is a function of E_c , the grid to cathode potential, and E_b/μ , the potential due to the anode voltage electrostatic flux penetrating between the grid wires. The " μ " is a characteristic of a triode which in turn is a function of the physical size and location of the grid structure. The total cathode current of an ideal triode can

be determined by the equation:

$$I_k = K \left(E_c + \frac{E_b}{\mu} \right)^{3/2}$$

I_k = cathode current

K = a constant determined by tube dimensions

E_c = grid voltage

E_b = anode voltage

μ = amplification factor of tube

One of the more important parameters of a triode is the amplification factor or “ μ ”. The μ of a triode can be determined from the equation:

$$\mu = \frac{\Delta E_b}{\Delta E_c} \quad \text{with the anode current held constant}$$

ΔE_b = change in anode voltage

ΔE_c = change in grid voltage

EIMAC manufactures triodes with μ values ranging from 5 to 200. The low μ tubes are generally used in audio service or any application which requires a large change in anode current without driving the tube into the positive grid region. The difference between a tube with a μ of 5 and one with a μ of 160 can be seen by comparing Figure 1 to Figure 2.

Observe how much more anode current at a given anode voltage can be obtained from the 3CX3000A1 (Figure 1) without driving the grid into the positive grid region. Note how much more bias voltage is required for the 3CX3000A1 to cut the anode current off at some given anode voltage. With this increased bias there is a corresponding increase in grid voltage swing to drive up to the zero grid voltage point on the curve. Low μ tubes have lower voltage gain by definition, and this fact can be seen by comparing Figure 1 and Figure 2.

Low μ tubes also are an excellent choice for series pass tubes in a voltage regulator. They operate over a wide range of load current (pass tube anode current) with low anode voltage drop.

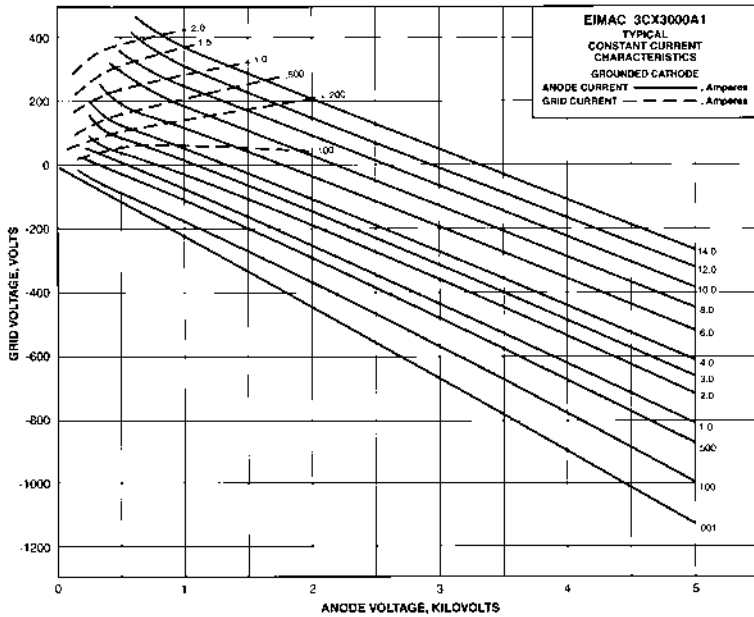

Figure 1: Constant current curves for 3CX3000A1 ($\mu = 5$).

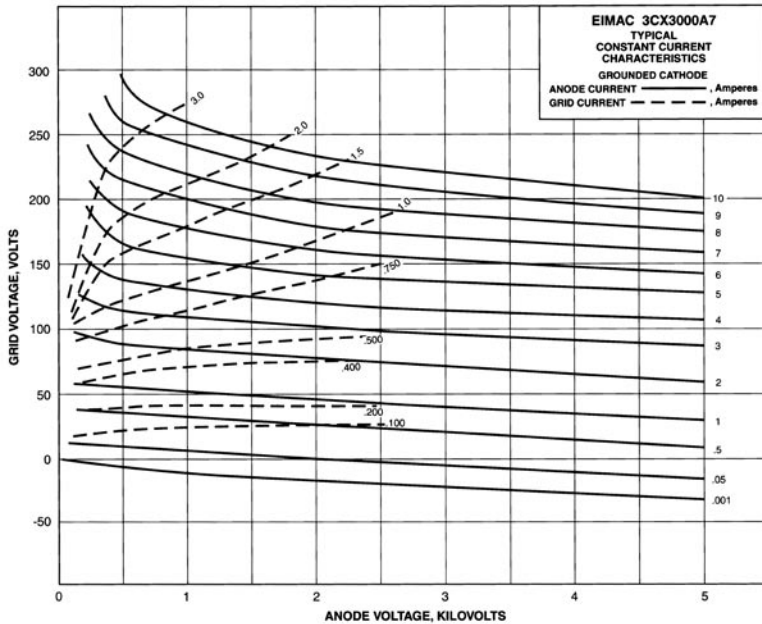

Figure 2: Constant current curves for 3CX3000A7 ($\mu = 160$).

Medium μ , (20-50) triodes are generally used in radio frequency amplifiers and oscillators. They are also good audio amplifiers and modulators.

The high μ (50 - 200) triodes have been designed so that the operating bias is zero in most applications (See Figure 3). EIMAC has developed a line of zero-bias triodes with anode dissipation ratings of from 400 to 30,000 Watts. The zero-bias triode is an excellent choice for grounded-grid radio frequency and audio frequency amplifiers. The main advantages are power gain and circuit simplicity. No bias supply is required. No protection circuits for loss of bias or drive are required.

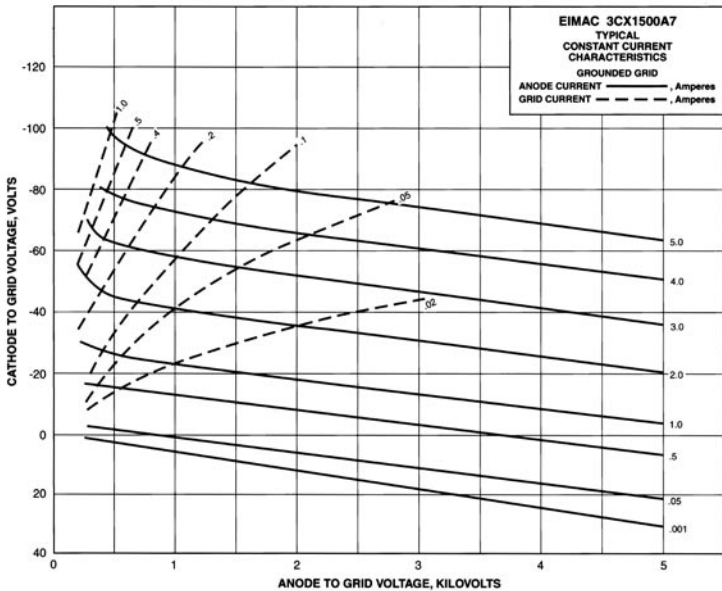

Figure 3: Constant current curves for a zero-bias triode with a μ of 200.

Low and medium μ rather than high μ tubes are usually preferred for industrial heating applications, such as simple oscillators constructed for induction and dielectric heating. The low-to-medium μ tubes are preferred because of the wide variation in load into which an industrial heating oscillator normally works. Low and medium μ triodes have a much lower grid current variation with the changing load. The grid current of a triode with a μ of 20 will rise far less than the grid current of a triode with a μ of 40 under no load conditions. High μ triode oscillators can be designed but extra consideration must be given to the grid current rise under the no load condition. EIMAC has developed a line of triodes specifically for industrial heating applications. These tubes have rugged mounting

flanges and flexible filament leads for ease of mounting in the circuit. Tubes are available with water cooling or forced air cooling. The filament structures are large with adequate cathode emission. The grid structures are ruggedly constructed with ample dissipation capability. The grid must be rugged for industrial heating triodes because of the wide variations in load. As the load decreases the grid dissipation increases. A good industrial triode must therefore be capable of operating with a reasonably wide range of load variations. For more information on tubes for industrial heating and related application notes, see Eimac's industrial catalog, "Rugged Triodes for R. F. Heating".

Most of the triodes manufactured by EIMAC are cylindrically symmetrical. That is, the filament or cathode structure, the grid, and the anode are all cylindrical in shape and are mounted with the axis of each cylinder along the center line of the tube. Some triodes are manufactured with the cathode, grid and anode in the shape of flat surfaces. The triodes so constructed are called "Planar" triodes (see Figure 4). This construction technique is necessary to provide very small spacing between the elements, and to achieve very short lead lengths within the tube. The very close spacings are necessary to reduce electron transit time¹ and therefore allow the tube to be used at frequencies up to 3 GHz and higher. The short leads also increase the operating frequency by reducing lead inductance. Planar triodes are normally used in radio frequency amplifiers in both the continuous wave and pulse modes. The contacting surfaces of the planar triode tubes are arranged for ease of design into coaxial and waveguide resonators.

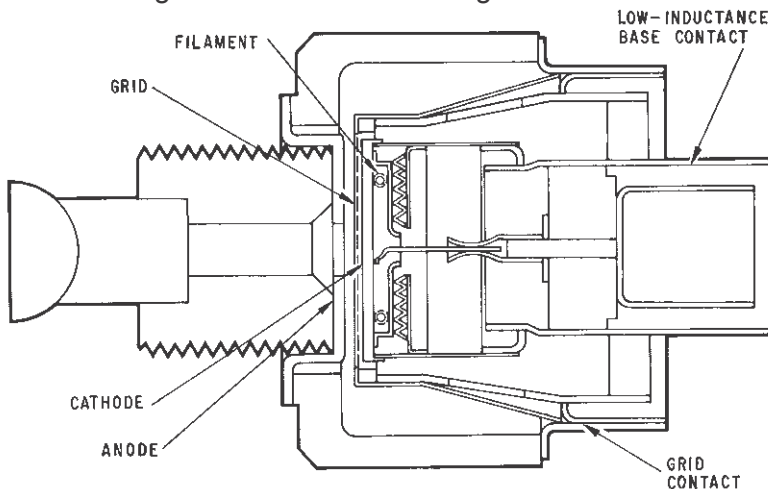

Figure 4: Internal configuration of a planar triode.

1 See section 6.8(d)

2.2 TETRODE

The tetrode is a four-element tube with two grids. The control grid serves the same purpose as the grid in a triode, while a second grid with the same number of bars as the control grid is mounted between the control grid and the anode. The grid bars of the second grid are mounted behind the control grid bars as observed from the cathode surface. Careful alignment of the grids is necessary to assure proper tetrode performance. The additional grid serves as a shield, or screen, between the input circuit and the output circuits of the tetrode, and is called a "screen grid." In addition to serving as a shield, the screen is the accelerating element attracting the electrons from the cathode. The total current from the cathode of a four-element tube is determined by the electrostatic field near the cathode, just as in the triode. The electrostatic field is a function of E_{c1} , the grid to cathode potential, and E_{c2}/μ_s , the potential due to the screen voltage electrostatic flux penetrating through the control grid wires. The anode voltage also contributes a small amount in the ratio of E_b/μ_p ; μ_p is usually so large in value that the anode voltage contribution is negligible. In an ideal tetrode there will be no anode current change with a change in anode voltage. A tetrode is therefore a constant current device. The screen voltage and control grid voltage determine the amount of anode current that will flow.

The total cathode current of an ideal tetrode can be obtained by the equation:

$$I_k = K \left(E_{c1} + \frac{E_{c2}}{\mu_s} + \frac{E_b}{\mu_p} \right)^{3/2}$$

I_k = cathode current

K = a constant determined by tube dimensions

E_{c1} = control grid voltage

E_{c2} = screen grid voltage

μ_s = screen amplification factor

μ_p = anode amplification factor

E_b = anode voltage

The arithmetic value of the screen μ (μ_s) is generally not used in the design of radio frequency and audio frequency amplifiers.

In most tetrode applications the screen amplification factor is useful to roughly categorize the performance to be expected.

The main advantages of a tetrode over a triode are:

- a. Internal anode-to-grid feedback is much lower due to the shielding effect of the screen grid.
- b. Tetrodes permit the design of amplifier stages, which can operate with driving power less than one per cent of the output power in most cases, and with negligible driving power in many audio applications.
- c. Tetrodes operate efficiently and with good life at audio and radio frequencies, including the VHF region (30 to 300 MHz) and in some cases into the UHF region (300 to 3000 MHz).
- d. Tetrodes allow designers to build compact, simple, flexible equipment with little spurious radiation.
- e. Tetrodes permit the designer to build linear amplifiers with low inter-modulation distortion products. (See Section 4.)

In designing equipment using power grid tubes, consideration must be given to unwanted electron emission from the control and screen grids. The grid materials will emit electrons as a primary emitter if the work function² of the grid surface material is low enough. The grid must be at a sufficiently high temperature for primary emission to occur. Primary grid emission is usually quite low in a thoriated tungsten filament type tube, because grid materials can be used which have high work functions. Also, the work function normally should not change significantly during the life of the tube. In the case of the oxide cathode emitter, the grid materials find themselves in a totally different environment. During the life of the tube, free barium evaporates from the cathode coating material. The rate of evaporation is a function of time and cathode temperature. Some of the free barium finds its way to the grids and they become another emitting surface. The hotter the grid, the more emission. Grids in oxide cathode tubes are often gold plated to reduce the amount of primary emission.

Another type of grid emission is secondary emission from the screen grid. The screen grid, which accelerates the electrons emitted from the cathode, is operated at a relatively low potential compared to the anode. Not all of the electrons pass through the screen grid on the way to the anode: some electrons are intercepted by the screen grid. In the process of striking the screen grid, other

2 Work Function - Expressed in electron volts. Electron Work Function represents the energy that must be supplied to an electron to cross over the surface barrier of a metal. The thermionic work function is of interest with power grid tubes. - See Data for Radio Engineers 5th edition Chap. 4-1.

low energy electrons are emitted, and are called “secondary electrons.” If these secondary electrons feel a stronger attraction by the screen, they will fall back into the screen. If, however, they find themselves out in the region between the screen grid and the anode, there is a very good chance that the much higher anode potential will attract them. The result is an electron flow from screen to anode. The control grid is not in this region and so has virtually no control over the number of secondary electrons flowing. During any part of the operating cycle of the tube it is possible that more electrons will leave the screen grid than will arrive. If this occurs, a dc current meter will indicate a reverse electron flow. On the other hand, if more electrons on the average are arriving than are leaving the screen grid, then the dc screen meter will indicate a forward electron flow. Reverse screen electron flow is quite normal for high power tetrodes. **The circuit designer must provide a low impedance path for the reverse electron flow.** EIMAC normally states on the data sheet the amount of bleeding current that must be provided from the screen power supply to counteract the emission current (see Figures 5, 6 and 7). If the screen power supply impedance is too high in the reverse electron flow direction, the screen voltage will attempt to rise to the anode voltage. Note the emphasis on low impedance in the reverse electron flow direction. Most regulated power supplies are low impedance in the forward electron flow direction only. If the supply is not well bled, the reverse electrons will try to flow in the negative direction in the screen supply regulator and cause the screen voltage to increase. As the screen voltage rises, the secondary and anode currents increase, and the tube is in a runaway condition.

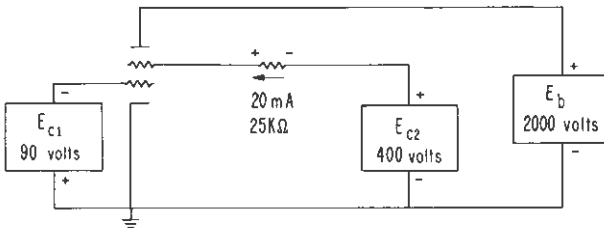

Figure 5: Incorrect screen circuit for tube requiring low impedance screen supply.

OBSERVATION

Assume that at some time during the tube’s operating cycle, the reverse electron flow is 20 mA. The voltage drop across the 25 K resistor will be 500 volts. Note the polarities. The effective screen-to-cathode voltage will be 900 volts. The increased screen voltage will increase the secondary emission.

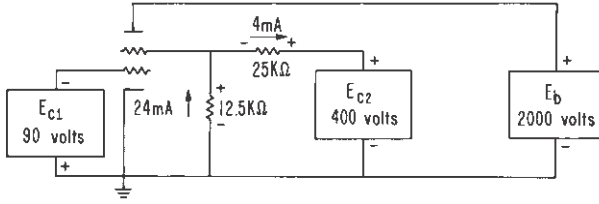

Figure 6: A correct screen circuit for tube requiring low impedance screen supply.

OBSERVATION

By the addition of a 12.5 K resistor from screen to ground, there will be a path for the grid emission 20 mA electron flow.

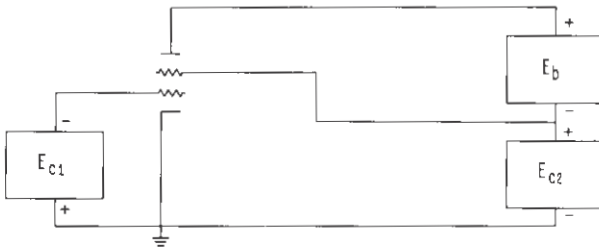

Figure 7: Another approach to swamping the screen circuit.

OBSERVATION

In the circuit of Figure 7, the anode current flows through the screen power supply, swamping the screen power supply. The screen power supply must carry the normal screen and anode current. This scheme is used quite extensively in circuits where the screen is operated at dc ground. The anode to cathode voltage is the sum of the \$E_b\$ and \$E_{c2}\$ power supplies.

The circuit designer must also consider the impedance of the control grid circuit. Primary grid emission can cause trouble if the grid circuit has too high an impedance.

The size and power of gridded tubes dictate certain characteristics of electrical potential. As this geometry increases in electrical

terms, secondary electron emission from the control grid can occur. The control grid secondary emission can be present whether the cathode is a thoriated tungsten or an oxide emitter, and can occur in a triode, tetrode or pentode. A typical curve of grid current as a function of grid voltage for a high power thoriated tungsten filament tetrode is shown in Figure 8.

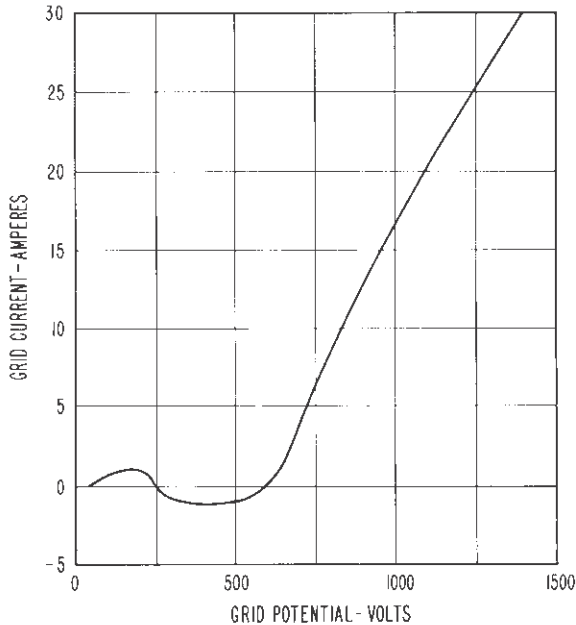

Figure 8. Typical curve of grid current as a function of control grid voltage for a high power thoriated tungsten filament tetrode.

OBSERVATION

In Figure 8, grid current decreases and eventually takes a reverse direction as the grid voltage increases. This reduction and reversal of grid current can be explained by the normal secondary emission characteristics of the metals used in the grid structure. In Figure 9, we see the secondary characteristics of the common metals presented in curve form, giving the ratio of secondary-to-primary electron current as a function of the primary electron potential.

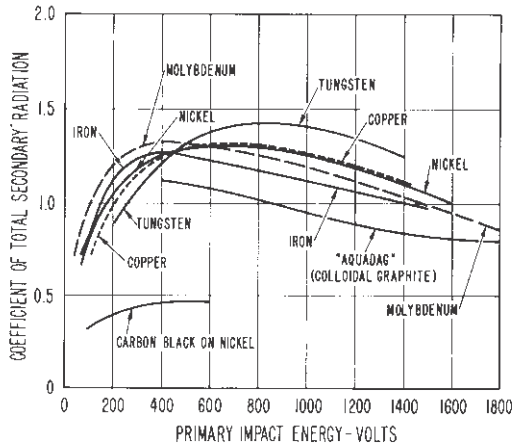

Figure 9. Secondary-emission characteristics of the metals under ordinary conditions. The curve shows the ratio of the number of secondary to primary electrons for various primary-electron impact velocities expressed in volts.

OBSERVATION

A study of Figure 9 shows the region between 200 and 600 volts to be a rather critical one as far as secondary emission is concerned. Any power grid tube which normally operates with 200 to 600 volts on the grid can exhibit the negative resistance characteristic of decreasing grid current with increasing grid voltage when another electrode, such as the anode in a triode or the screen grid in a tetrode, is at a sufficiently high potential to attract the emitted electrons. A driver stage which works into such a non-linear load normally must be designed in such a manner as to tolerate this condition. One technique would be to swamp the driver so that the change in load due to secondary grid emission is a small percentage of the total load the driver works into.

2.3 PENTODES

The pentode is a five-electrode tube; it has three grids. The control grid and screen grids perform the same function as in the tetrode. The third grid, the suppressor grid, is mounted in the region between the screen grid and the anode. The suppressor grid produces a potential minimum in the anode-screen space. This potential minimum prevents secondary electrons from being interchanged between screen and anode.

Following the analogy with the tetrode tube, the electrostatic field at the surface of the cathode is proportional to the anode voltage in a pentode.

The anode voltage in a pentode has even less effect on the total space current than in the tetrode. The same total space current equation holds:

$$I_k = K \left(E_{c1} + \frac{E_{c2}}{\mu_s} \right)^{3/2}$$

The suppressor grid may be operated negative or positive with respect to the cathode, and may be operated at cathode potential. It is possible to control the anode current by means of adjusting the suppressor grid potential. Because of this characteristic, it is possible to amplitude modulate an amplifier by applying the modulating voltage to the suppressor grid. The modulating power will be quite low because of the very low electron interception of the typical suppressor grid.

The main advantages of a pentode are:

- a. Secondary emission effects reduced.
- b. An approach to better linearity when used in linear amplifier service.
- c. It is possible to swing the anode voltage below the screen voltage without exceeding screen dissipation. This characteristic sometimes allows slightly higher power output for a given anode voltage.

Since the suppressor grid reduces the effects of secondary emission, screen grid power supply requirement to provide a reverse electron flow path may be reduced. The screen current requirement for a pentode may be somewhat higher than that for a tetrode of the same general characteristics; control grid power supply requirements will be the same as outlined for tetrodes.

2.4 Current Division

The actual value of cathode current in a power grid tube is the sum of the control grid current, the screen grid current in a tetrode, suppressor grid current in a pentode, and the anode current.

The term *current division* is used to describe the process where electrons on the way to the anode are intercepted by the control grid (or the screen grid in a tetrode). Control grid interception is inevitable when the grid is positive with respect to the cathode, due

to the proximity of the two elements. The screen grid is shadowed behind the control grid to minimize interception. But, due to it being substantially positive in voltage, the actual screen current will depend on anode voltage; because, as the anode voltage drops, the screen current increases.

By examining the constant-current curves for a particular power grid tube, one can see the effects of electron intercept. At positive grid voltages, the instantaneous values of grid current rise exponentially as the voltage is increased. Grid conductance draws power from the driving signal and the result is waveform distortion, an important consideration in linear amplifiers.

It can be seen that the anode-current curves begin to slope upward at low plate voltage, this is called the *saturation region*. In a triode all additional cathode current will begin flowing to the grid if the tube is in saturation, because as the anode voltage is decreasing it attracts fewer electrons. In tetrodes the screen current rises similarly. This loss of cathode current results in less available anode current, which is the equivalent of reduced output, but a more serious consequence is increased dissipation of the grid(s).

Using the constant-current curves for the 3CX1500A7 (Fig. 3) as an example, we see a worst-case condition where a current division of 20% may occur. Note that with a grid voltage of 100 Volts above zero (the polarity in grounded-grid curves is opposite that of cathode driven curves) an anode current of 5 amperes is obtained at $e_{b_{min}} = 500$ V and at this point the grid current will be 1 ampere. The total peak cathode current in this example is 6 amperes. It should be noted that these are instantaneous values; average (dc) current values will be considerably less. It is permissible to operate a tube under these conditions if the average current and dissipation ratings are not exceeded. Pulse modulators and switch tube applications make use of this. A method of using constant-current curves to calculate the average values of current that will be obtained in a sine-wave amplifier will be discussed in sec. 3.2.

It should be pointed out that secondary emission currents are an integral part of constant current curves. Any signs of an "island" or sudden departure from a normally smooth curve indicate the effects of secondary emission. An example of this can be seen in fig. 27 the screen current of 0.4 ampere can be seen as an "S" shape where it crosses the zero grid voltage line. Likewise, the control grid current rises from 0.25 ampere at a grid voltage of approx. 35 Volts, to 0.48 ampere at 50 Volts, then at approx. 120 volts it drops back to 0.25 ampere. This non-monotonic behavior clearly indicates secondary emission and is normal phenomena in power grid tubes.

Special factory tests are performed against test specifications that measure secondary emission of individual tube elements, allowing Quality Assurance to monitor parameters that would be otherwise difficult to measure in the field. The product uniformity that results from this care helps to maintain performance in product manufactured over long periods of time with little or no change in operating conditions. A wise circuit designer will however provide sufficient control over power supply voltages in order to accommodate slight variations in tube geometry as well as the fact that cathode emission does not remain constant over the life of a tube.

2.5 **INDUCTIVE OUTPUT TUBE (IOT)**

The Eimac Division of CPI, Inc. pioneered the introduction of one of the most significant energy efficient tubes, the IOT. Originally it was used mainly in UHF TV broadcasting, but has since then found applications in industrial and scientific markets.

2.5.1 The History of the IOT

Invented by Haeff and Nergaard, the IOT was first described by Haeff in 1939 (*Electronics*) and again, with Nergaard in 1940 (*Proceedings IRE*). In the early 1980's, Shrader and Preist³ developed a commercial version which Eimac introduced as the Klystrode® IOT – a name coined by realizing the device had the properties of a **klystron** and **tetrode**. This energy saving device was more efficient than klystrons then used in UHF television broadcast. The first IOT began broadcast service in 1988 at WCES, and as a result Eimac was awarded an Emmy for engineering excellence in 1990.

Today, most high power UHF television stations utilize IOT power amplifiers for both NTSC and 8-VSB digital television. Other applications in the scientific community also employ IOT power amplifiers.

Present day IOT amplifiers consist of both the Inductive Output Tube (IOT) and cavity hardware (see Figure 10).

3 D. Preist, M. Shrader, "The Klystrode, an Unusual Transmitting Tube with Potential for UHF-TV", IEEE Proc., Vol 70, No. 11, Nov. 1982

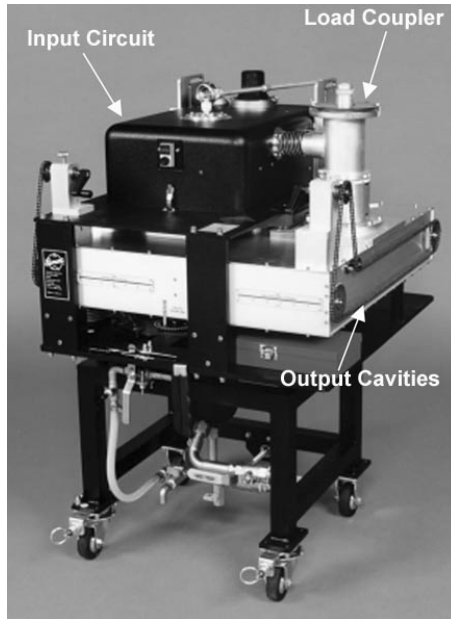

Figure 10: Eimac K2 IOT Amplifier

The hardware has an input cavity that is usually driven by a wide-band solid-state driver. The input is tuned by varying the input cavity dimensions and is matched to the driver with a stub tuner. The IOT forms a density modulated linear beam that traverses a short drift tube and is coupled to the output cavities at the tube's output gap. The kinetic energy of the high-velocity beam at the output gap is transformed to electromagnetic energy in the primary output cavity. A secondary cavity creates an over-coupled double-tuned response to obtain the 7 to 9 MHz bandwidth needed for UHF-TV application. The amplified RF signal is then coupled to the antenna system by a probe in the secondary cavity. The spent beam is intercepted by the water-cooled collector and is dissipated as heat.

2.5.2 IOT System Considerations

UHF-TV IOT systems operate at between 27 kV and 38 kV anode accelerating voltage. The anode and collector are at ground potential with the cathode operated at -27 to -38 kV with respect to the anode. With these potential levels, consideration has to be given to high voltage arcing. The small interior volume of the IOT requires that the tube be protected from internal arcs. This arc protection is accomplished by crowbar circuitry, which monitors any

sharply increased cathode current and causes either a thyratron or spark gap to conduct the arc energy directly to ground, diverting an arcing event from being absorbed by tube components.

Early IOT amplifiers were completely air-cooled. However, with the trend to higher power, a combination of air and water cooling is used. Generally, the cathode, grid, input cavity and output cavities are air-cooled. The collector is usually water-cooled (or a 50% water/glycol mixture). Higher power amplifiers may also require water cooling of the IOT anode and/or output cavity assemblies. New developments in multi-staged, depressed collector IOTs may require oil, deionized water or other collector cooling schemes.

2.5.3 IOT System Description

The major assemblies of an IOT are the gun, anode, output gap and collector assemblies (see Figure 11). The gun assembly includes the source for the electron beam and the control grid. The geometry of these components starts shaping the electron beam. A major component of the anode assembly is the drift tube through which the modulated, laminar beam is directed. Ideally, the anode intercepts none of the beam current.

IOT electron emission starts with an indirectly heated dispenser cathode. The cathode is concave, which, in conjunction with the corresponding anode and focus electrode geometry, starts shaping and focusing the electron beam to pass through the drift tube in the anode on its way to the output gap. An applied magnetic field aids in keeping the beam coherent through the drift tube and output gap.

A pyrolytic graphite control grid is mounted in very close proximity to the cathode. This grid must conform to the cathode radius with a very high degree of accuracy. Pyrolytic graphite is used for the grid because it is a rugged material that can handle high operating temperatures while retaining its shape. Pyrolytic graphite grids are formed by depositing a graphite cup on a mandrel in a high-vacuum, high-temperature furnace. The graphite cups are then cut with a laser beam to form the final grid.

The cathode is operated at -27 kV to -38 kV with respect to the anode. The grid is biased from -45 to -80 Volts with respect to the cathode. The level of grid bias determines the operating mode of the IOT amplifier.



Figure 11: Eimac K2 Inductive Output Tube

An RF signal is coupled between the cathode and grid, causing the electron beam to be density modulated. The focused and modulated beam then goes through the drift tube in the anode to the output gap where the kinetic energy of the beam is converted into electromagnetic energy in the output cavities.

Typical IOT conversion efficiencies at peak power can be in the range of 30 -55%, depending upon the type signal. This means that the remaining 70-45% power in the lower power, spent beam will be dissipated as heat in the collector. This heat is carried away by water cooling the collector.

The IOT hardware consists of three basic active parts, the input tuning section, the output cavities and the output load coupler. The hardware also provides for air and water cooling of the IOT and cavity systems. Additionally, the hardware frame is part of the IOT focus magnet frame.

The input circuit is designed to cover the full UHF (470-860 MHz) frequency band. It forms a resonator, which imparts a RF field between the cathode and grid of the IOT. A paddle inside the cavity and a shorting stub on the top portion of the input circuit are adjusted for resonance and impedance matching at the desired frequency. Shorting pins are used in the input resonator to determine the

range covered by the paddle tuner. DC electrical connections for the heater, cathode, grid and Vaclon pump are located in the input circuit assembly.

The output cavity assembly has a primary and secondary cavity. An adjustable iris opening capacitively couples these cavities. Both the primary and secondary cavity walls are movable to make the output circuit resonant at a selected frequency within the UHF TV band. The bandwidth of the system is adjusted by the position of the iris paddle.

Energy in the secondary output cavity is extracted through a coaxial probe located in the secondary cavity. Adjustment of the output probe depth controls the secondary cavity loading.

2.5.4 IOT Tuning

Eimac Inductive Output Tubes use indirectly heated tungsten-matrix type (dispenser) cathodes. This requires a warm-up period for the cathode heater before high voltage is applied to the IOT. When the cathode heater is first switched on, the heater current must be limited to 15 Amps maximum. As the heater warms up, the heater current will stabilize at approximately 8.0 to 9.0 amps. The heater power should be nominally 80 Watts at normal operating temperatures. Once the heater current is stabilized, the high voltage may be applied between the cathode and anode.

Grid bias should be adjusted to obtain a quiescent (no RF) beam current of 400 to 800 mA. The quiescent beam current will determine the basic operating mode of the IOT amplifier (class A, B, AB, C). Class AB is the usual TV mode of operation.

It is important to remember that input RF power should be limited until course tuning of both the input and output cavities is finished. This prevents dissipating too much power in the collector.

Input tuning of the IOT amplifier is best accomplished using a sweep generator and spectrum analyzer as instrumentation. The sweep generator is set at the center frequency of the channel being tuned. The sweep width is adjusted between 10 MHz to 25 MHz. The wider bandwidth is used for rough tuning, with the narrower bandwidth being used for final adjustments.

The frequency range of the input cavity is determined by shorting pins in the cavity. Normally, this range is set at the factory and

requires change only if the TV channel will be changed. Fine tuning of the input frequency is accomplished by a ten-turn adjusting knob on the front of the input circuit assembly. The input is matched to the drive with a stub tuner (see Figure 12 for an example of input tuning using the reflected drive signal. The lowest part of the reflected signal is generally set at the center frequency of the channel. The stub tuner is set to obtain the deepest response of the reflected signal.)

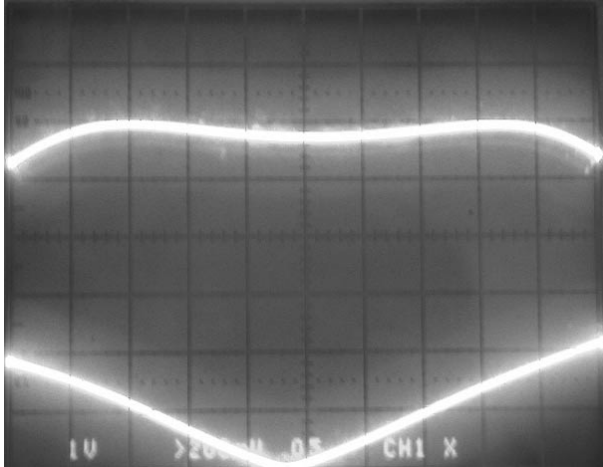

Figure 12: Typical tuning curves for UHF TV IOT. The lower curve is the reflected drive signal. The upper curve shows the output tuning.

For output tuning, the spectrum analyzer is connected to the sampled output power of the transmitter. Basically, the primary output cavity tuning controls the low frequency side of the pass band and the secondary cavity tuning controls the high frequency side of the bandpass signal. The iris coupler between the cavities controls the bandwidth and the load coupler adjustment controls the dip in the middle of the signal (see Figure 12).

2.6 MULTISTAGE DEPRESSED COLLECTOR IOT (MSDC IOT)

Because of significantly higher efficiency, i.e., the ratio of RF power out to total input power, standard IOT amplifiers have almost completely replaced previous types of power amplifiers for high power UHF broadcast transmitters. Higher efficiencies result in lower electricity usage. One way of further increasing the efficiency of IOT amplifiers is Multistage Depressed Collector technology.

A portion of the IOT's electron beam is not converted to RF energy at the output gap of the tube. This portion is called the spent beam. The spent beam can be between 50% to 70% of the total beam power.

This spent beam is directed to a collector, where most of the electron energy is dissipated as heat. This heat is wasted power, which can be partially recovered as electrical power.

Multistage Depressed Collector Inductive Output Tubes slow down electrons before they strike the surface of the collector, thereby, allowing recovery of electrical power from the spent beam by collecting the electrons as electrical current instead of generating heat. Basically, the collector is divided into one or more stages that are biased at increasing percentages of the cathode to anode potential. All of these stages are at a lower (or equal) voltages than the cathode to anode voltage. Therefore, they are called depressed voltages or depressed collectors. These depressed voltages set up equipotential fields in the collector that slow down electrons in the spent beam (see Figure 13). Ideally, the electrons are nearly stopped when they strike the collector (see Figures 14 & 15).

The number of depressed collectors and the voltages on the collectors is highly dependent upon the distribution of electron velocities in the spent electron beam. IOTs have a very uniform electron energy distribution in their spent beam. This is largely because of the more efficient density modulation (as opposed to bunching) used for IOTs. The result is that excellent power recovery can be accomplished with few depressed collector stages.

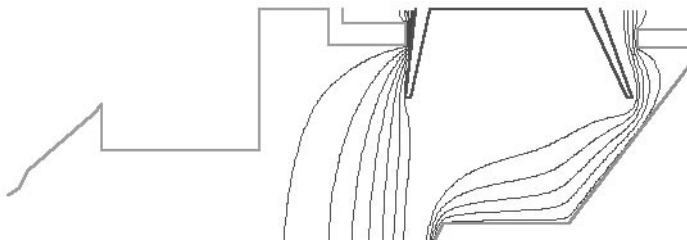

Figure 13: Equipotential lines in a three stage collector. The potentials are determined by collector geometry and collector voltages.

Ultimately, the number of collector stages used is a trade-off between the efficiency gained and the complexity of the power supply and tube fabrication. Multistage Depressed Collector

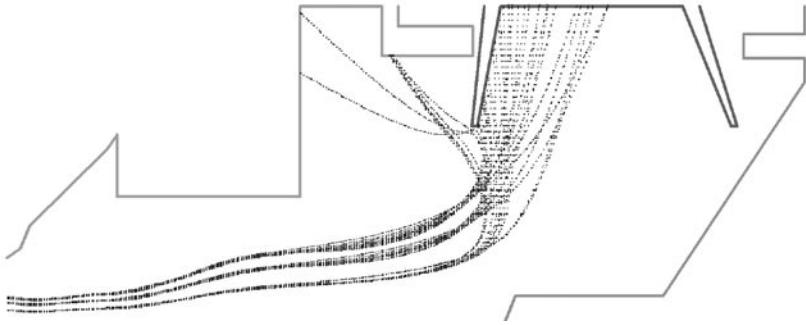

Figure 14: Electron trajectories at near to ideal power. The tube gap is at the left side of the image, which is only half the collector. The right collector element is at cathode to anode potential. The middle section is approximately half the cathode voltage. The left side collector element could be at ground potential.

Inductive Output Tubes have been demonstrated with three to five stages. Adding additional stages brings very little more efficiency gain.

One of the consequences of depressed collector design is more complex collector cooling considerations. Standard IOTs have a single collector at ground potential. This type of collector can be directly cooled by water, or a water/glycol mixture. The MSDC IOT has several collector stages at differing voltages ranging from ground to cathode potential. Cooling these collector stages requires some dielectric material to carry the heat away from the collector. MSDC collectors are commonly cooled by using air, deionized water or dielectric oil.

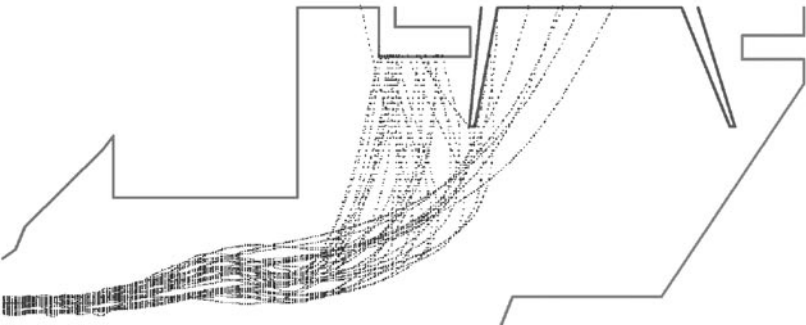

Figure 15: Electron trajectories at higher than ideal power. Less power is recovered in the middle, depressed collector segment.

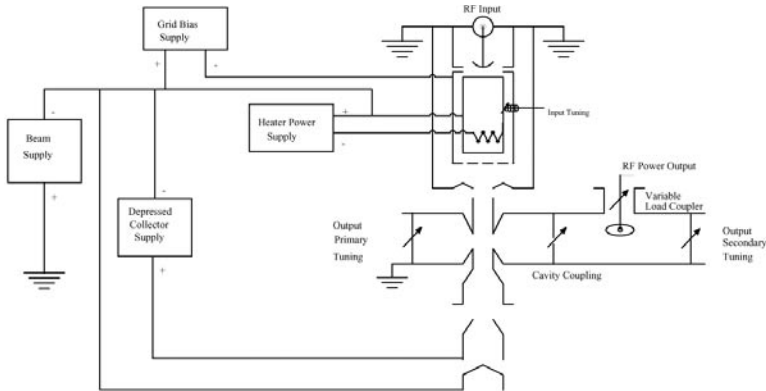

Figure 16: Typical MSDC IOT power supply schematic

2.7 CATHODE EMITTERS

2.7.1 Oxide Cathodes

The typical production-type oxide cathode is a coating of barium and strontium oxides on a base metal such as nickel. The oxide layer is formed by first coating a nickel can or disc with a mixture of barium and strontium carbonates, suspended in a binder material. The mixture is approximately 60 per cent barium carbonate and 40 per cent strontium carbonate. During vacuum processing of the tubes, they are baked out at high temperature. The binder is burned away, and the carbonates are subsequently reduced to oxides. The cathode is now “activated” and will emit electrons when hot. The typical oxide cathode operates at 1000° Kelvin and is capable of 200 mA to 300 mA per cm² of CW emission. High emission current capability for each Watt of heating power is one of the main advantages of the oxide cathode. Other advantages are high peak emission capability for short pulses, a low operating temperature and greater mechanical ruggedness compared to some other cathode configurations.

The high peak emission for short pulse operation (defined as approximately 10-20 μs) is often considered the most significant advantage of the oxide cathode. Oxide cathodes can provide peak emission in the range of 1 to 3 A/cm² for short pulse applications. The wide range reflects variation in factors such as cathode temperature, spacing, desired operation life and other details of the tube design and operating conditions. Peak emission for a given tube type is related to pulse width and duty. This is due to the fact that the ability of the cathode to emit electrons is rapidly depleted in high current density operation and, thus, a recovery time is needed between pulses. Figure 17 shows a pulse derating curve that is typical for oxide cathode tubes.

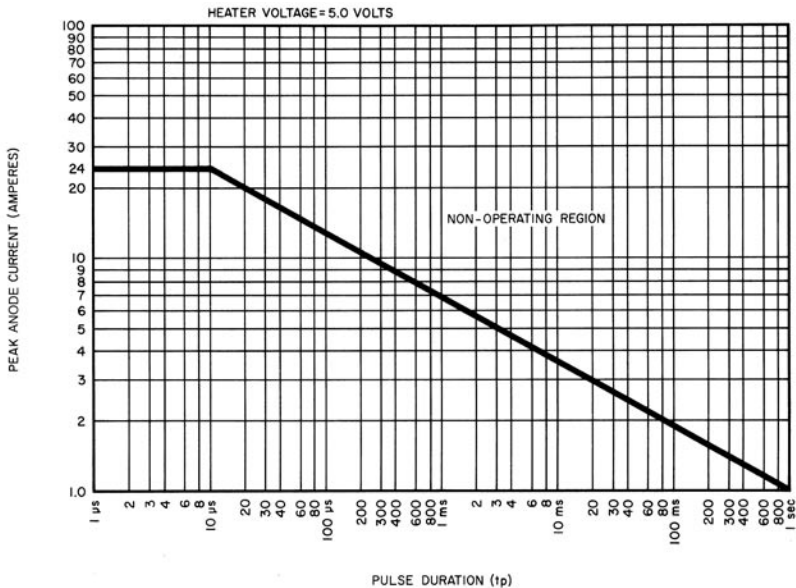

PULSE DERATING DATA, TYPE 3CPX1500A7 - PULSE MODULATOR OR REGULATOR SERVICE
 Peak (pulse) anode current capability is dependent on pulse duration (tp) and duty factor (Du).
 Maximum peak anode current for a given value of tp is shown. Maximum Du may then be
 derived from the relationship: $1.0 = i_b \sqrt{D_u}$

Figure 17: Pulse derating curve

Oxide cathodes are susceptible to deterioration due to ion bombardment. Thus, oxide-cathode tubes are usually operated at lower anode voltages because of this characteristic. Fortunately, higher voltage is very seldom needed because of the high currents available at lower voltage. Backheating is of similar concern in oxide cathode tubes operating at UHF. See Section 6.11.4

The oxide cathode material will evaporate during the life of the tube, causing free barium to migrate to other areas within the tube. The evaporation can be minimized in the design by means of a high efficiency cathode which runs as cool as possible but still is not emission-limited at the desired heater voltage. In the field, the heater voltage must not exceed the rated nominal value. An oxide cathode which is overheated gives very little more useful emission, but the life of the tube is shortened significantly. Reducing the heater voltage in an oxide cathode tube will conserve oxide material but this reduces emission capabilities. Fortunately most applications use far less than the available cathode emission, so heater voltage reduction will, if properly performed, result in a worthwhile increase in tube life.

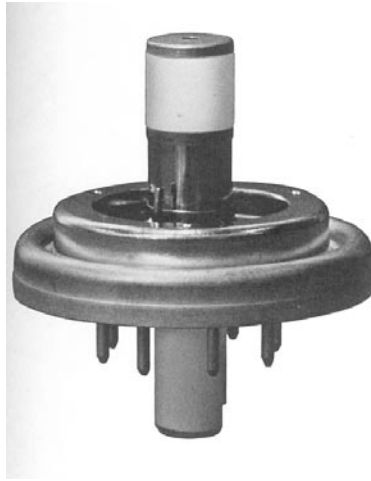

Figure 18: Typical oxide cathode.

It should be noted that because a reduction in heater voltage to an optimum value will increase the life of a tube, an even greater reduction is not likely to prove worthwhile because chemical degradation may begin to occur, sometimes referred to as “poisoning” of the cathode. This is when the temperature of the cathode is too low to prevent the rate of absorption of gas into the cathode and emission is reduced to the point that sparking may occur, causing irreversible damage to the cathode. Under these conditions the cathode may induce a localized arc and the resultant gas may ionize and precipitate a plate-to-cathode arc. Arc protection is discussed further in sec. 3.9.1. Figure 18 is representative of an oxide cathode.

2.7.2 Thoriated Tungsten Cathodes

A thoriated tungsten filament is one form of an atomic-film emitter. Thorium is added to the tungsten in the process of making tungsten wire. Typically, about 1.5 per cent of thorium in the form of thoria (thorium oxide, ThO_2) is added. By proper processing during vacuum pumping of the tube envelope, the metallic thorium is brought to the surface of the filament wire, and emission increases approximately 1000 times. The thoriated tungsten filament is also carburized. The small amount of tungsten carbide formed in the carburizing process reduces the evaporation rate of the thorium and thus increases the life of the filament. At a typical operating temperature of approximately 1900°K , a thoriated tungsten filament will produce a specific peak emission of about 500 mA/cm^2 .

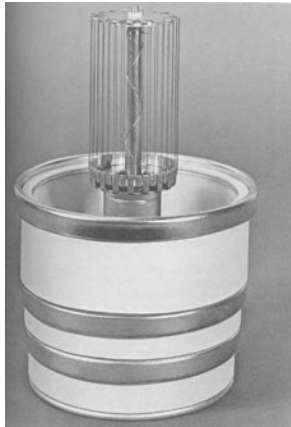

Figure 19: Typical bar tungsten filament

For a thoriated tungsten cathode, peak and average emission are essentially the same. A thoriated tungsten filament is more tolerant of ion bombardment than an oxide cathode, and, therefore, higher voltages can be applied to the tube.

Thoriated tungsten filaments can be assembled in several different configurations. Figures 19 and 20 show typical bar and mesh filament construction techniques. As the size of the tube increases, mechanical considerations dictate the bar filament construction technique with spring loading to compensate for thermal expansion. The mesh filament can be used on both small and larger tubes, and is more rugged, therefore, less subject to damage from shock and vibration.

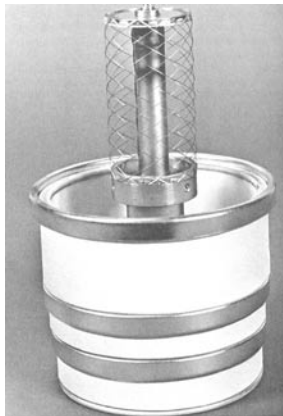

Figure 20. Typical mesh tungsten filament.

2.7.3 Gun Type Emitters

Some power grid tubes are designed as a series of electron gun structures arranged in a cylinder around a center line. This type of construction allows large amounts of anode current to flow and be controlled with a minimum amount of grid interception. With reduced grid interception, less power is dissipated in the grid structures. In the case of the control grid, less driving power is required. The typical configuration used by Eimac is called a focus cathode. This structure is essentially an oxide cathode emitter where the emitting material is applied in stripes to the cathode substrate. The tube is assembled such that these stripes of emitting material are aligned with the opening between grid bars. Thus, the grid can produce the voltage gradient needed to accelerate the electrons from the cathode while interception of electrons by the grid is minimized.

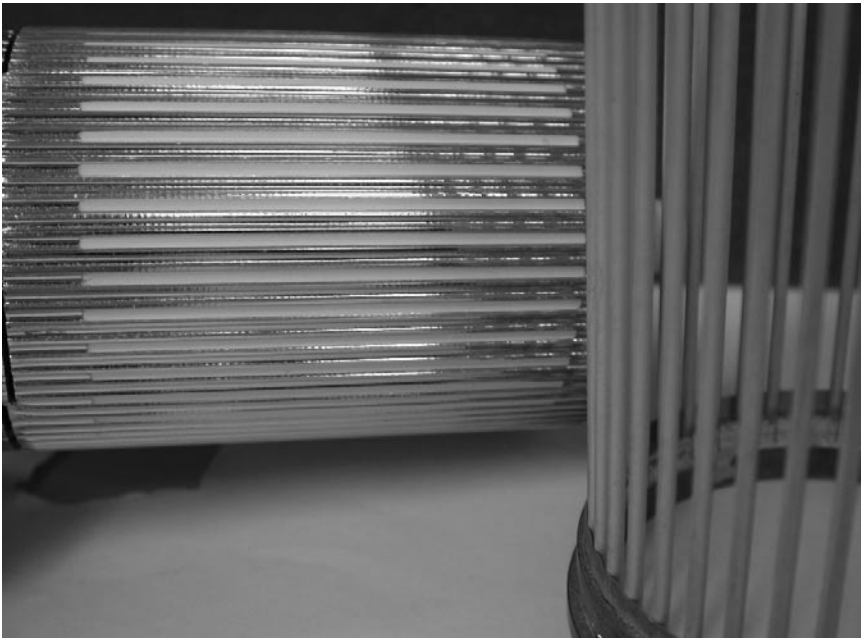

Figure 21: Typical Focus Cathode (LPT-62). The horizontal assembly is the cathode assembly. The white area between the shiny bars is the actual cathode emitting areas. The shiny bars are essentially shadow grids. This cathode assembly is mounted inside the grid assembly (shown vertically at the right) with the shadow grid bars lined-up exactly with the control grid bars. This minimizes control grid interception of electrons.

2.7.4 Tungsten Matrix Cathodes (Dispenser Cathode)

Tungsten matrix (also known as dispenser) cathodes are widely used in linear beam devices such as the klystron, traveling wave tube or IOT, but are also finding wider use in power grid tubes. The Klystrode® IOT discussed in Section 2.4 is a good example of a gridded tube that uses a tungsten-matrix cathode. The matrix cathode design takes advantage of some of the best attributes of both oxide and thoriated tungsten cathodes. This cathode is made of a porous tungsten “sponge” that is impregnated with electron emitting materials similar to those used in oxide cathode tubes. It is generally indirectly heated as is an oxide cathode. Tungsten-matrix cathodes are very rugged both mechanically and electrically. They are much more resistant to damage by ion bombardment than is the oxide cathode. Although heating power requirements are greater than for a similar size oxide cathode, these requirements are significantly less than needed for a thoriated tungsten cathode. The matrix cathode can provide peak emissions of 10 A/cm² and average emission of 1 A/cm². The large amount of emitting material dispersed throughout the tungsten “sponge” results in long operating life for tubes with a matrix cathode.



Figure 22: Tungsten Matrix (Dispenser) Cathode from a K2 series Inductive Output Tube.

2.8 GRIDS

The electrical performance of a power grid tube is determined to a high degree by the type and quality of the grid(s) employed in it. A grid must be thin enough that it appears almost “transparent” to the flow of electrons, yet thick enough that it is a rugged, self-supporting

structure capable of withstanding shock and vibration. Cylindrical shaped grid structures must retain their shape after many thermal cycles, to prevent shorting to the filament or cathode.

Grids in most power grid tubes are made from wire or bars of tungsten or molybdenum, elements that are capable of withstanding the high operating temperatures encountered without melting. These wires are welded at many points to produce the desired shape, then coated with materials that assure low secondary emission. The coating material specified is determined by the final product design. Grids used in high μ tubes often employ platinum cladding, while tubes in medium and low μ tubes employ an Eimac-proprietary coating called Y3. Grids used in oxide cathode tubes use gold plating, as described previously.

A relatively new grid material is pyrolytic graphite (PG). PG is made in a special chemical vapor deposition (CVD) process. In this CVD process, a mixture of methane and hydrogen gas under specific conditions of pressure and temperature are applied to a polished graphite mandrel. The grain growth that occurs at the molecular level results in a unique material that has thermal conductivity in certain directions that is very similar to that of metals. The fact that PG withstands extreme temperatures makes it desirable for use in high power tubes like the 4CM2500KG, which has a screen grid dissipation rating of 20 kilowatts.

PG has a very low coefficient of expansion, almost identical to that of copper. This ensures the internal spacing between the filament or cathode and the control grid will not vary significantly, regardless of grid temperature. Over the life of the tube, the shape of a PG grid will not change, ensuring uniform performance

PG is easily machined after it is removed from the mandrel and it can be cut into an almost infinite variety of apertures using a computer-controlled laser. This procedure provides for excellent parts-uniformity, thereby, guaranteeing consistent tube-to-tube performance.

Grid dissipation ratings must be respected to prevent loss of coating or possible melting of the base metal. Conventional wire grids have dissipation ratings that vary from 25 Watts in small tubes and, in very high power tubes, may have dissipation ratings as high as 20 kilowatts.

Grids in planar triodes are made from very thin tungsten wire, as small as 0.8 mils, and are gold plated to reduce primary and secondary grid emission. Grid dissipation ratings of planar triodes

are low, compared to larger power grid tubes, and are typically on the order of 1.5 to about 2 Watts.

The subject of grid protection is discussed in sec. 3.9 and should be considered one of the circuit designer's most important items of concern.

2.9 Anodes

In addition to being the area with the greatest mass in most tubes, the anode (in most cases the anode cooler, actually) serves as a contact point for external circuitry. Larger power grid tubes employ a lifting device such as handles or points where a hoist may be applied for lifting the tube from the packing crate and installation into equipment.

Electrons arriving at the anode (or collector in the case of an IOT) impart energy, depending on the accelerating voltage and the value of electron current. In addition to heat from the impact of electrons, there is some energy arriving from the filament in thoriated-tungsten tubes. Of the total power applied to the filament approx. 80 to 85% appears as heat on the anode surface. Heating from this effect is minimal in oxide cathode tubes and not generally considered as part of the total anode heating. The subject of anode cooling is covered in more detail in sec. 6.10.

The anode in most power grid tubes is fabricated using a particular grade of Oxygen Free, High Conductivity (OFHC) copper, deep drawn and machined. A few high voltage switch tubes are made using anodes consisting of vacuum-cast copper; in this technique gases are removed from the copper while it is molten and the shape determined by molding process.

Great care during vacuum pumping is necessary to remove gases that are trapped in all materials. During this process, the tube is heated by an application of external power. This "bake-out" process is very effective in removing internal gas down to the molecular level, thereby, achieving a good vacuum; only then is the tube sealed-off and removed from the pump.

However, free gas molecules will always be present to some degree in a fully processed tube. Gas, particularly oxygen containing compounds, may chemically combine with the cathode material to either permanently or temporarily destroy the electron emission capability. Free gas molecules, when struck by electrons moving from cathode to anode, may be ionized by having one or more electrons knocked from their molecular structure. If enough

such ions, plus the freed electrons from the ionization process, are present in the tube, a conduction path is provided, which is not subject to control by the grid. This can result in runaway arcing, which may involve all elements of the tube.

The anode is intentionally spaced fairly close to the grid/cathode structure to attract electrons, but far enough away to prevent breakdown or arcing under normal operating conditions. Although the anode is machined to a smooth surface, microscopic points, which grow from grain boundaries, project from all such metallic surfaces. These tiny projections can develop voltage gradients large enough, that when combined with free electrons, can promote low current paths (arcing) between tube elements. Free electrons are electrons from sources other than the cathode, such as electrons freed from molecules by ionization.

These tiny metallic projections must be removed by a process called “spot knocking” or “debarnacling.” In this process, controlled energy is applied at increasingly higher voltages to induce field emission until controlled arcing occurs at these undesirable points, thereby, melting the projections and leaving a smooth surface.

In some power grid tubes, particularly those that operate at anode voltages greater than 10 kilovolts, a reprocessing in the field may be recommended if the tube has been in storage for a substantial period of time.

It is, however, recommended that only an experienced professional who is trained in the use of high voltage equipment attempt this processing. Of equal importance is the need for using the correct power source otherwise more harm than good may result. The actual energy available to the tube during this process is determined by the value of capacitance used for an energy storage device, as well as the series resistance chosen.

Application Bulletin No. 21, “Conditioning of Large Radio-Frequency Power Tubes,” describes this subject in greater detail and is available at the Eimac web site, www.eimac.com, under Applications.

2.10 VACION PUMPS

Power grid tubes used in very high power amplifiers use anode voltages that may exceed 20 kV. Some pulse modulator tubes operate at 100 kV or higher.

At these voltages, any residual gas that may accumulate in the vacuum space will ionize and an internal arc may occur (this subject is discussed in detail in section 3.9). To prevent arc damage, a means of detecting and measuring gas within the tube is desirable.

Several Eimac high power tubes have a device called a Vaclon pump incorporated that acts as a vacuum gauge for the tube and preserves the high vacuum necessary for proper operation. The Vaclon pump captures any gas molecules that enter it by forcing the molecules to collect on a gettering surface (gettering devices use a chemically active material to trap and hold gas molecules in its molecular structure).

Vaclon pumps are basically diodes with a cold cathode (field emission device) that emits electrons when high voltage is applied between the anode and cathode. These electrons are sent into a spiraling path by an applied magnetic field toward the anode. Any gas molecules that are encountered along the way are ionized. Ionization produces further electrons, which continue the process in an avalanche manner. The positive gas ions are accelerated to the negative electrode, which is fabricated from titanium, where the ion is either implanted or is trapped chemically in the negative electrode.

High voltage power for Vaclon pumps is usually 3 to 4 kV and current limited to less than approximately 5 mA dc. The current is metered. Because ionization of gas molecules produce additional free electrons, any current that flows is directly related to the amount of gas ions that are present in the vacuum space. Thus, the ion pump current can be used to monitor the relative quality of the vacuum in the tube over a period of time.

Under operating conditions, the ion pump current can be a sensitive indication of tube elements that are near the upper limits of rated dissipation capability. For instance, if anode dissipation limits, which can be in the range of hundreds of Watts per cm² in high power amplifiers, are exceeded, localized tube element melting may occur. This melting will release gas molecules into the vacuum. These molecules will cause higher ion pump current, which, once certain current levels are exceeded, will cause a fault condition in interlock circuits and will remove power from the tube.

Once a fault is detected, the ion pump, performing its primary function, brings the tube back down to standard operating vacuum levels, if possible.

High power amplifiers using Vaclon pump equipped tubes can be designed to allow monitoring for internal gas that may be released under worst-case situations, making the ion pump a handy tool for the system operator. Using Vaclon monitoring, a system operator can make corrections to prevent tube damage, thereby improving overall reliability.